

Employer Roadmap

CHILDCARE SOLUTIONS FOR WORKING PARENTS

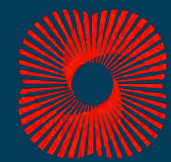

U.S. Chamber of Commerce
Foundation

uschamberfoundation.org/earlyed

ABOUT THIS ROADMAP

NOW IS THE TIME.

Working parents have long struggled to access the affordable, quality childcare that enables them to participate in the workforce, but COVID-19 has made things even worse. The resulting impact on our workforce and organizations of every size and sector is more acute than ever and, for employers, it's affecting their bottom line.

For the duration of the pandemic, the U.S. Chamber of Commerce Foundation has received hundreds of queries from businesses regarding strategies to support working parents.

But understanding an employer's options and navigating the childcare landscape can be complex and overwhelming.

This roadmap is intended to help senior leaders and business owners learn their options for supporting working parents with their childcare needs. It is also intended to help leaders understand what to expect when embarking on this journey and how to take action.

//

76% of businesses said they've seen employees leave – 43% of those businesses said that 75-100% of the employees they lost were women

U.S. CHAMBER FOUNDATION SURVEY 2020



WHO IS THIS ROADMAP FOR?

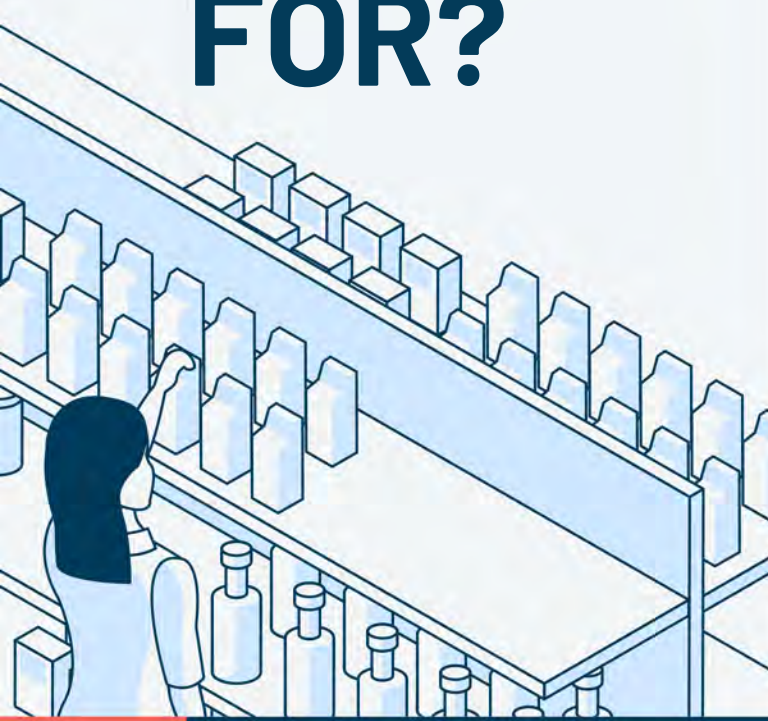

EXECUTIVE LEADERSHIP

Childcare doesn't happen without C-suite leadership across functions.

CEO

Leadership at the top is essential to ensuring sustainable solutions.

COO

Assesses the impact across the organization to determine the best approach.

CFO

Guides the organization towards the most sustainable childcare investments and bottom line impact.

CMO

Leads strategy to bolster brand, community, and market positioning.

CHRO

Engages working parents and communicates those needs to all other senior leadership.

INDUSTRIES

Industries of all sectors, but especially those employing frontline and shift workers, will begin seeing immediate benefits by providing quality childcare support to their shift-based employees.

Hospitality

Post-pandemic, hospitality will need to find and retain skilled staff to accommodate increased travel and tourism.

Retail

Retail companies will need to ensure that childcare is not a barrier for staff who may be hesitant to enter the space.

Healthcare

With highly specialized staff and unconventional hours, childcare is essential to support a stable, qualified workforce.

Manufacturing

With manufacturing labor in short supply, childcare helps to retain skilled workers and improve safety and productivity on the floor.

Food Service

Eliminating childcare barriers is a strategic way to find stability in an industry with above average employee turnover.

Grocery

Essential workers at grocery retailers will continue to need available, affordable childcare to fulfill a vital role in their communities.

Agriculture

As other industries recover, agricultural employers will need remain competitive in acquiring employees.

YOU ARE ALREADY PAYING FOR THE LACK OF CHILDCARE

Access to high-quality childcare is an unforeseen and overlooked cost to employers, causing high turnover rates and absenteeism, reducing productivity, and impacting recruitment of skilled staff. Employers who operate shift work during non-traditional hours are even more impacted by the childcare challenges facing parents. Listening to your working parents, noticing trends in employment, and considering what solutions might work best for your organization are essential to maximizing the full potential of your organization and employees.

THE FACTS

- Parents must balance the availability, affordability, and quality of their childcare options when making employment decisions. Parents working non-traditional hours have even fewer options to consider.
- Finding and retaining skilled talent was a top concern for employers prior to the pandemic; the challenge is only increasing as we look ahead to recovery.
- Childcare responsibilities fall disproportionately on female caregivers, especially women of color.
- Employers committed to diversify their workforce must recognize that childcare challenges work against efforts to recruit, retain, and grow skilled female employees.

EMPLOYEE TURNOVER COSTS

33%

of a worker's total compensation—including income and benefits—to replace them.



How are employees impacted?

66%

of employers expressed willingness to increase childcare supports.

62%

cited childcare as a factor for why they're seeing employees leave the workforce.

1 IN 3

businesses felt that childcare issues factored "a great deal" into loss of productivity for employees.

BEYOND THE BOTTOM LINE

Investments in high quality childcare result in wide-ranging positive business outcomes.



EMPLOYEE PERFORMANCE

Quality childcare decreases absenteeism, improves productivity, safety of operations and quality (especially in manufacturing), and increases employee commitment and loyalty.

WHO BENEFITS:

FINANCE HR

OPERATIONS

ORGANIZATIONAL GROWTH

Quality childcare is a critical lever to ensure healthy local economic growth and a skilled and stable workforce.

WHO BENEFITS:

FINANCE OPERATIONS MARKETING

DIVERSITY & INCLUSION HR

RECRUITMENT & RETENTION

Quality childcare investments signal workforce value to prospective employees, providing competitive differentiation, reducing turnover costs and increasing diversity of recruitment.

WHO BENEFITS:

FINANCE HR

DIVERSITY & INCLUSION

COMMUNITY STANDING

Organizations that make investments in quality childcare show a commitment to their workers, their local economies, and their customers.

WHO BENEFITS:

MARKETING PHILANTHROPY

DIVERSITY & INCLUSION

BRAND IMPACT

Investments in quality childcare demonstrate leadership within the organization's sector, reflect organizational values and culture, and increase brand awareness with employees, customers, suppliers, and competitors.

WHO BENEFITS:

MARKETING

PHILANTHROPY

WHAT ARE YOUR OPTIONS?

QUICK WINS

WORKING PARENT SUPPORT

Complexity: +

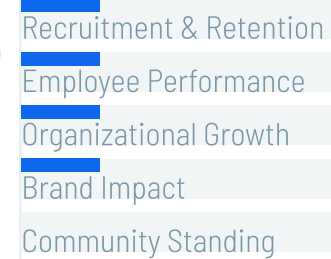

Leverage existing organizational programs to support working parents.

FLEXIBLE SCHEDULING

Complexity: ++

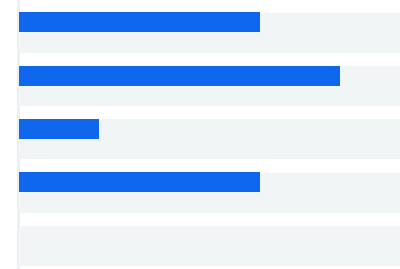

Accommodating work schedules that create stability and predictability for working parents.

INTERNAL INVESTMENTS

BACKUP CARE

Complexity: ++

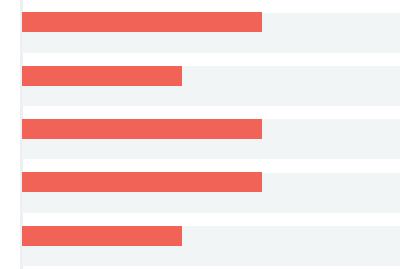

Temporary childcare for unforeseen last-minute changes.

CHILDCARE VOUCHERS

Complexity: ++

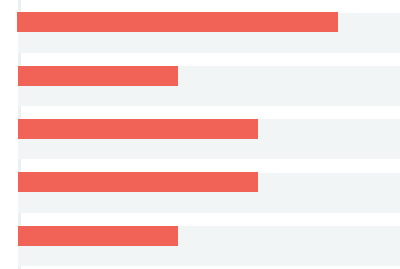

Help working parents access or afford locally-available childcare.

SUBSIDIES

Complexity: +++

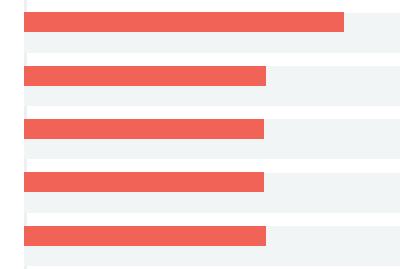

Help working parents access or afford locally-available childcare.

ONSITE CARE

Complexity: ++++

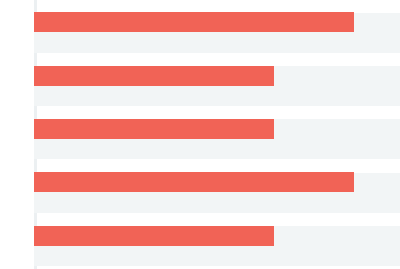

Provide quality childcare exactly where parents need it—at work.

COMMUNITY INVESTMENTS

PUBLIC ADVOCACY

Complexity: ++

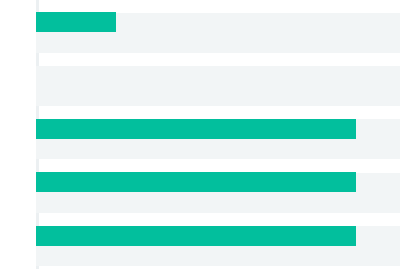

Using your organization as a platform to address childcare quality, access and affordability at a local, state and/or national level.

EXPAND COMMUNITY CAPACITY

Complexity: +++

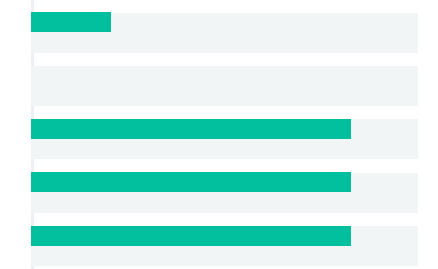

Ways to build community capacity and supply for childcare, benefitting your working parents in the process.

IMPACT

QUICK WINS

WORKING PARENT SUPPORT

Existing organizational programs, like Employee Assistance Programs (EAPs) and Enterprise Resource Groups (ERGs), can be used to disseminate resources, information, and create formal networks of working parents to support each other and provide the organization with input and feedback.

- Low-to-no cost first step response
- EAPs are an easy way to disseminate organization-vetted resources or vendors for working parents
- An ERG can help working parents connect with one another, share resources, build community, and jointly suggest possible solutions for the organization



i Things to Consider

BE PREPARED TO RESPOND

If sponsoring a working parent ERG, make sure the executive team is prepared to respond to ideas and suggestions.

MAKE IT OFFICIAL

Identify an executive sponsor that can help draw participants to an ERG, determine responsibilities, and officially charter it.

INTEGRATE PROGRESS INTO ORGANIZATION

Identify opportunities to integrate the work of the EAP and/or ERG across the organization, into onboarding processes or staff training opportunities, to ensure all staff are aware of the available supports for working parents.

THE JOURNEY

1 IDENTIFY WHAT IS ALREADY HAPPENING

Determine what resources are currently being provided to working parents, understand if they are well-utilized, and see if your EAP program includes information about them. Check if your organization already has a working parent ERG.

2 BUILD UPON CURRENT EFFORTS

See if there are opportunities to update your EAP to better disseminate resources and information. If you don't already have a working parent ERG, engage your employees to see if they would want to start one.

3 EXPAND RESOURCES

Listen to working parents' needs and consider offering more resources through the EAP to better meet their caregiving needs.

4 CREATE FEEDBACK LOOPS

Determine what ongoing data and feedback is needed from the EAP and/or ERG to stay responsive to parents' needs.

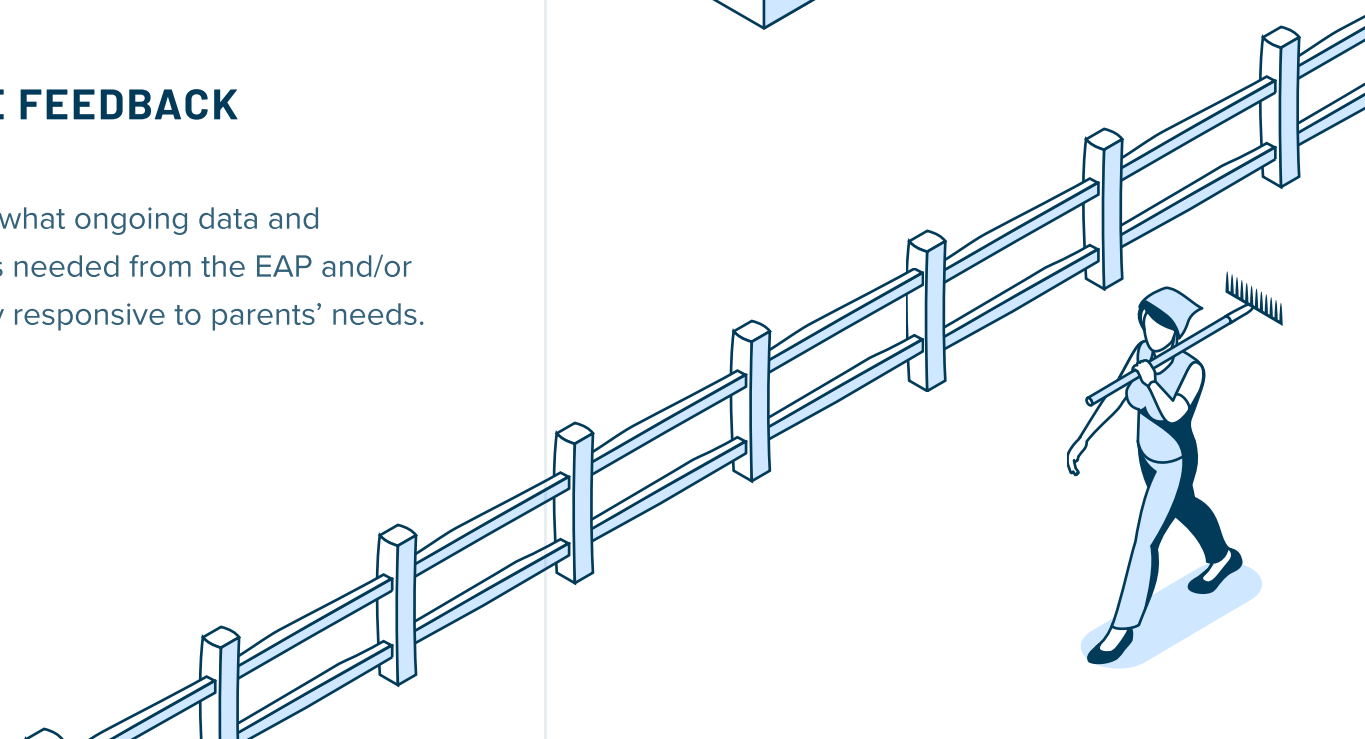
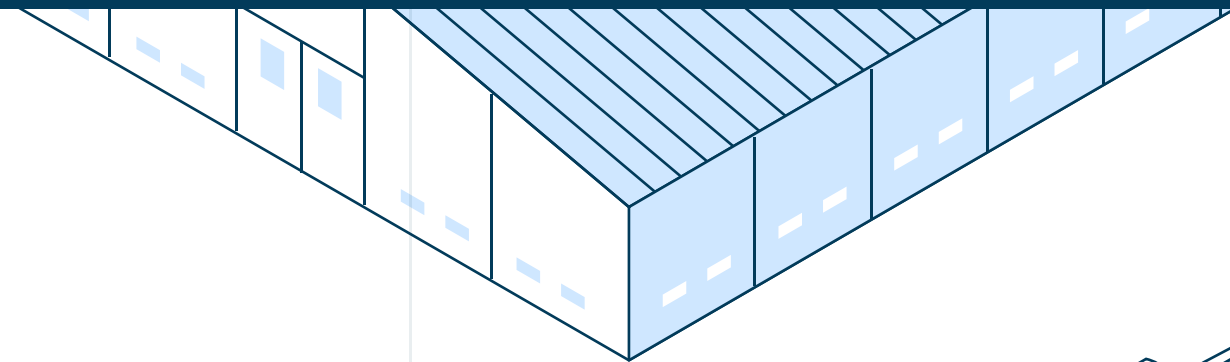

QUICK WINS

FLEXIBLE SCHEDULING



Flexible scheduling adjusts hours and days to accommodate the childcare needs of working parents. Depending on the specific needs, finding care outside of traditional working hours can be extremely difficult. Allowing for flexibility gives parents more control and the ability to find care that fits their schedules.

- Multiple ways to execute
- Low cost, minimal resources
- Sustainable, long-term impact and viability
- Immediate impact to culture
- Flexibility may be constrained with shipment requirements, product assembly requirements, safety regulations, optimal business hours etc.

i Things to Consider

IDENTIFY BRIGHT SPOTS

Look for teams that have already instituted flexibility that might be scalable.

ONE SIZE MIGHT NOT FIT ALL

Consider different types of flexibility for different teams. Teams may have varied needs and flexibility.

GET CREATIVE

Are there flexible options that you haven't considered, such as days, hours, time blocks, or predictive scheduling?

CREATE LEARNING LOOPS

Consider coding shifts to track if/when working parents are adjusting schedules due to childcare needs.

THE JOURNEY

1

ASSESS YOUR WORKING PARENTS' NEEDS

Understand how childcare contributes to last-minute scheduling changes. Find out who your working parents are and identify what data you need to gather and how to access it. Talk to working parents directly to get their input.

2

TALK TO YOUR OPS TEAM AND LINE MANAGERS

Understand how last minute childcare breakdowns impact business during high-needs shifts and what systems can be leveraged to facilitate flexible or predictive scheduling.

3

FIND OUT WHERE THERE IS FLEXIBILITY IN THE BUSINESS

Open lines of communication with line managers to explore what's possible. Identify how and when flexibility could be utilized.

4

IMPLEMENT AND COMMUNICATE

Once it's determined how to introduce flexibility into shifts, create a plan to communicate these changes. Start at the leadership level and work down towards employees.

5

TRACK THE IMPACT

Track missed shifts due to childcare needs. Plan for feedback from employees on a regular basis to understand how flexibility changes are working.

BACKUP CARE

Last minute changes to childcare arrangements are unforeseen and directly impact parents' ability to show up and engage productively at work. These breakdowns are often overlooked by employers, but have a relatively simple fix. Offering backup care is a quick solution which decreases absenteeism in the short term.

- Direct impact to short-term ability to show for work
- Cost proportional to size of employee base/need
- Local childcare providers may have limited availability but more flexibility compared to larger providers
- Subject to union/labor environment complexities
- Opportunity to select quality providers for employees to utilize.



i Things to Consider

GET CLEAR ON THE BUSINESS IMPACT

Understand the frequency of missed shifts and the resources spent addressing those losses. What are your current work-arounds? How do they impact quality, efficiency and safety? This can be a hidden cost to the business.

ENSURE FIT WITH WORKFORCE NEEDS

When scheduling backup care, your partner may not be able to cover your high-need shifts (i.e., if night or early morning shifts are particularly important to your business). Look into home-based vs. center-based programs, quality of the programs, viability and sustainability.

ASSESS THE SEASONALITY OF CHILDCARE NEEDS

Examine seasonality differences in utilization and alignment to important months for your business (i.e., summers, holiday seasons).

THE JOURNEY

1

ASSESS YOUR WORKING PARENTS' NEEDS

Understand last-minute scheduling changes related to childcare and its impact on your business. Find out who your working parents are and identify what data you need to gather and how to access it. Talk to working parents directly to get their input.

2

TALK TO YOUR OPS TEAM AND LINE MANAGERS

Understand how last minute childcare breakdowns impact business during high-needs shifts, especially for non-traditional hours.

3

FIND YOUR PARTNERS AND UNDERSTAND YOUR OPTIONS

Determine capacity of local providers to assist with back-up care or commit to larger, multi-state providers who can offer this option. Understand fit in terms of quality, capacity, cost, viability, and sustainability.

4

DECIDE AND IMPLEMENT

When you've identified your partners, determine your level of financial commitment to offset the cost of backup care.

5

TRACK THE IMPACT

Once you've implemented, gather data on utilization. Create ways to get feedback from working parents on a regular basis.

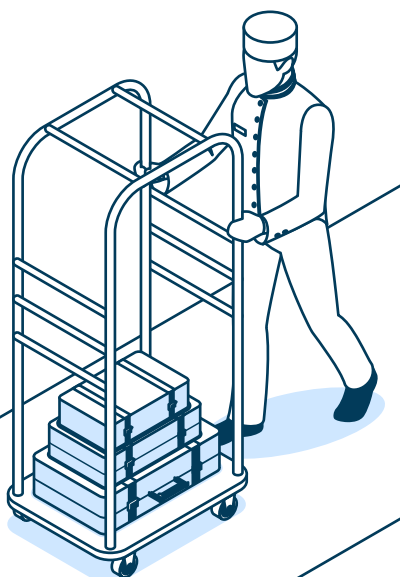

SUBSIDIES + VOUCHERS

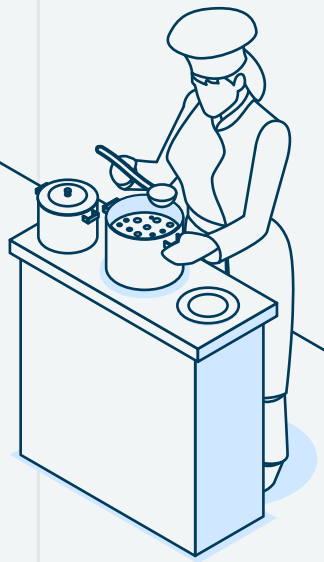

Childcare affordability is often a high barrier for families. Through vouchers or subsidies, employers can help offset the cost of care and incentivize quality options. Vouchers can be given directly to employer-approved childcare providers or directly to working parents, providing them control over where to send their child. Subsidies enable employers to reserve capacity (slots) for their employees in nearby childcare programs and incentivize quality options. Employers can determine if they help offset the cost of care.

- Cost proportional to size of need
- Availability of quality providers varies based on location
- Sustainably improves childcare access
- Subject to union and labor environment complexities



i Things to Consider

GET CLEAR ON YOUR METRICS AND OUTCOMES

Make sure you have clear line of sight into what needs you are trying to help your working parents address (i.e., availability, affordability, quality).

VOUCHERS, SUBSIDIES OR BOTH?

Vouchers align with employee choice and offer a flexible disbursement structure (i.e. they can be given to providers or directly to working parents). Subsidies offset the cost of care in addition to reserving slots. Both improve access and can come with tax incentives for your business.

QUALITY MATTERS

Consider leveraging both vouchers and subsidies to incentivize quality childcare options and maximize your investment.

THE JOURNEY

1 ASSESS YOUR WORKING PARENTS' NEEDS

Understand what childcare options your working parents currently utilize and why. Find out who your working parents are and identify what data you need to gather and how to access it. Talk to working parents directly to get their input.

2 CHECK CHILDCARE SUBSIDY REGULATIONS

Your employees (especially lower-wage) might qualify for existing childcare subsidies. Income thresholds varies by state.

3 UNDERSTAND YOUR OPTIONS

Understand the universe of locally available supply of childcare. Local Childcare Resource and Referral agencies (CCR&R) can connect you to all the licensed providers in your area.

4 DECIDE AND IMPLEMENT

Determine if your organization will reserve slots for guaranteed access to nearby care for your employees, help offset the cost of care, or offer vouchers directly to employees.

5 COMMUNICATE

Create a communications plan that clarifies the value to employees at all levels. Explain the rationale for your choices.

6 TRACK THE IMPACT

Gather data on utilization, solicit feedback from working parents, and assess impact on recruitment, retention, and absenteeism.

ONSITE CARE

This option addresses the access, affordability, and quality needs for working parents looking for care. Employers can operate the onsite care themselves or partner with an external childcare provider to manage the operation.

- Direct control over access, affordability, and quality
- Self- or partner-operated
- If multiple locations, this option presents challenge with providing equitable benefits to all employees
- Significant investment and time commitment—up to 1.5 years to launch
- May be challenging to meet demand, depending on geographic footprint
- Subject to union and labor environment complexities
- Local provider partners may have limited availability compared to larger providers



Things to Consider

YOUR CAPACITY MIGHT NOT MEET THE DEMAND

If that's the case, expect to work through how your organization will prioritize demand.

DON'T LET THE JOURNEY SURPRISE YOU

Know the inherent complexities and common decisions that have to be made before you commit. This will help you work through challenges and roadblocks with your teams.

EXPLORE WAYS TO OFFSET YOUR COSTS

Look into existing subsidies, quality/facilities grants, partnering with other employers, tax benefits, and incentives.

ESTABLISH YOUR METRICS

Measure the impact of this investment on recruitment, retention, absenteeism, and other aspects of your business that are important to you.

THE JOURNEY

1 ASSESS YOUR WORKING PARENTS' NEEDS

Understand the size of demand and projected usage. Find out who your working parents are and identify what data you need to gather and how to access it. Talk directly to working parents to understand their needs.

2 CREATE A CROSS-FUNCTIONAL TASK FORCE

Compose a leadership team with HR, Finance, Tax, Operations, Legal, Compliance, IT, Security, Supply Chain, etc., to address the complexity of this undertaking.

3 DO YOUR HOMEWORK

Research the landscape and assess what is within organizational capacity. Your state lead agency and Child Care Resource and Referral agency (CCR&R) can help identify providers and builders familiar with childcare requirements.

4 BUILD AND LAUNCH

Obtain permits, supplies, build the building/renovate space.

5 TRACK THE IMPACT

Gather data on utilization. Create and implement feedback mechanisms to obtain input from parents on a regular basis.

PUBLIC ADVOCACY

Public advocacy at the local, state, and/or federal level could address the need for access, affordability, and quality childcare. Usually, this advocacy is informed by or in partnership with childcare organizations.

- Ability to impact and build capacity in your community at scale
- Benefits both your community and your organization
- Positively impact brand and establish industry leadership and influence
- Can be politically complex, depending on the environment
- Can create scrutiny on employer investments in childcare and working parents
- Often involves partnering with existing childcare coalitions
- Subject to union/labor environment complexities
- Long-term commitment

i Things to Consider

LEARN THE BASICS BEFORE YOU ENGAGE

Understand how childcare is funded and regulated in your areas of interest.

KNOW YOUR POLICY PRIORITIES

Determine your asks. Make sure these asks don't come in conflict with other policy priorities you have as an organization.

UNDERSTAND WHO'S WHO AND WHAT THEY CARE ABOUT

Get to know the key players and their public agendas. Identify budget and legislative priorities that represent opportunities for influence.

USE YOUR ORGANIZATION'S VOICE FOR MAXIMUM IMPACT

Look for ways to maximize impact further by collaborating with other employers and/or chambers. Incorporate working parent voices/stories into your advocacy.

THE JOURNEY

1 IDENTIFY YOUR INFLUENCERS

Your state and local chamber government relations teams can help connect you to the key players. Elected officials (state or local) can be some of your biggest champions. Talk to your CCR&Rs about local and state advocacy organizations. (See Resources: p. 16)

2 LEARN THE LANDSCAPE

Understand policy and funding streams and the dynamics between access, affordability, and quality. Explore if there are existing childcare policy agendas that can be supported or leveraged.

3 BUILD GRASSROOTS SUPPORT

Get your working parents' voices involved in the advocacy efforts. Are there others who are in supply chain, distributors, vendors, etc. who aren't just working parents but might strengthen the network?

4 DETERMINE YOUR ADVOCACY AGENDA

Assess your asks and positions relative to other public advocacy or policy agendas you care about.

5 DEVELOP A STRATEGY FOR ADVOCACY

Consider collaborating with other employers or chambers to maximize impact. Seek out existing coalitions. Incorporate parent voices into your advocacy efforts.

6 KEEP AT IT

Advocacy is a long-term approach. You might not see immediate results, but it can pay off big down the road.

EXPAND COMMUNITY CAPACITY

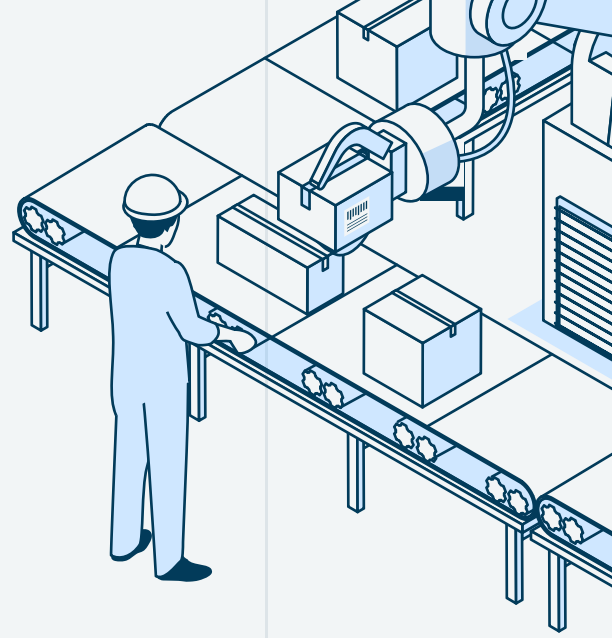

Shared services are collaborations with providers to pool administrative tasks such as HR, accounting, purchasing, etc. to help childcare providers focus on delivering quality childcare. Employer involvement in these alliances include, but are not limited to, “in-kind” donations of staff time, products, and financial support.

- Improves the supply of quality care in the community - ultimately benefiting employers
- Multiple ways to participate, via an existing alliance or creating one anew
- Numerous ways to contribute, including administrative services (HR, accounting, purchasing) or in-kind donations of product and financial support (i.e, philanthropy)
- Scaled, long-term impact



Things to Consider

LOOK FOR EXISTING OVERLAPS

If there are shared alliances in your communities, look into if your working parents access care in any programs that are already a part of shared services alliances.

INTEGRATE CHILDCARE BUSINESSES INTO LOCAL NETWORKS

Description: Invite childcare providers into the small business community and encourage membership in local and regional chambers.

DEFINE YOUR DESIRED OUTCOME

Determine how to enable shared service alliances for local providers. How might this impact quality care and childcare supply in your community?

PHILANTHROPIC OPPORTUNITIES

Explore leveraging local philanthropic giving to directly support childcare providers.

THE JOURNEY

1

FIND OUT IF THERE IS A SHARED SERVICES ALLIANCE IN YOUR AREA

If there's not one, research what a shared service alliance (SSA) could be. (See Resources: p. 16)

2

IDENTIFY OPPORTUNITIES FOR SUPPORT

Understand what kind of support providers in the community need and what role your organization could play in fulfilling those needs.

3

PARTICIPATE AND CONTRIBUTE

Continue to leverage your organizational capacity towards the shared goal of improving childcare. This is a valuable communications opportunity to reiterate the impact.

4

TRACK YOUR IMPACT

Understand the impact to your community's childcare supply and quality in addition to the impact to your organization.

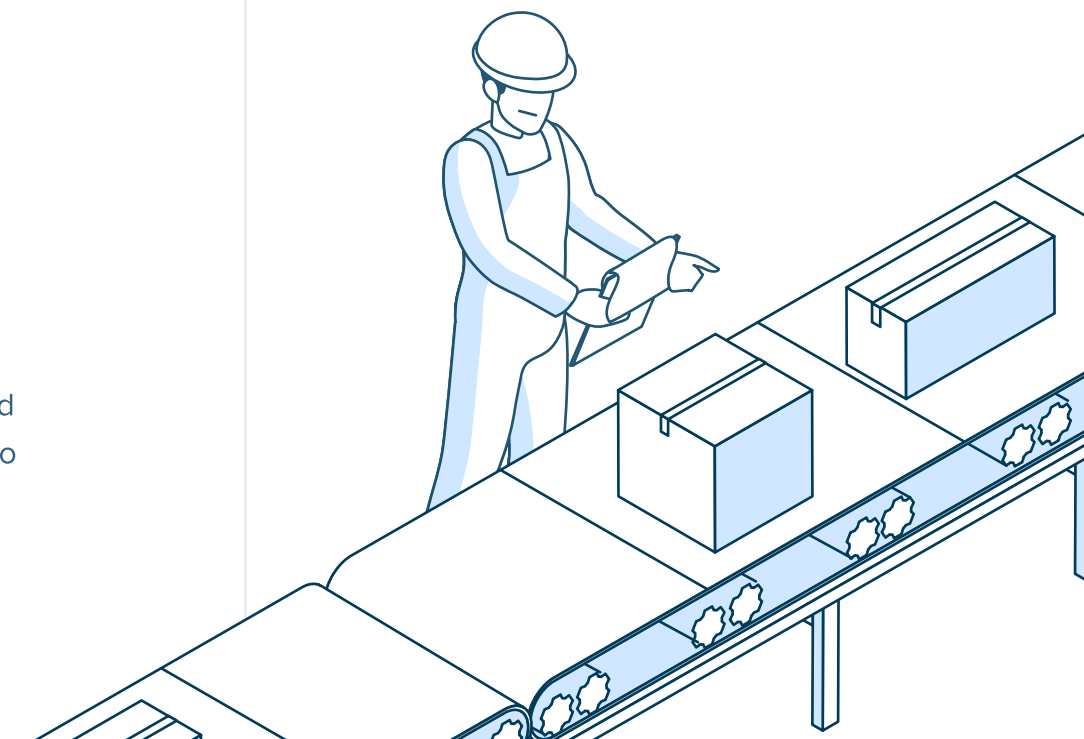

COMMON COMBINATIONS

Many employers use a combination of solutions to meet their working parents' childcare needs. Implementing multiple solutions is an approach used to ensure equitable benefits are offered to working parents across locations or teams.

The combinations shown here are not a recommendation, nor an exhaustive list. Rather, they are meant to help you think about what approaches may work best for your organization.

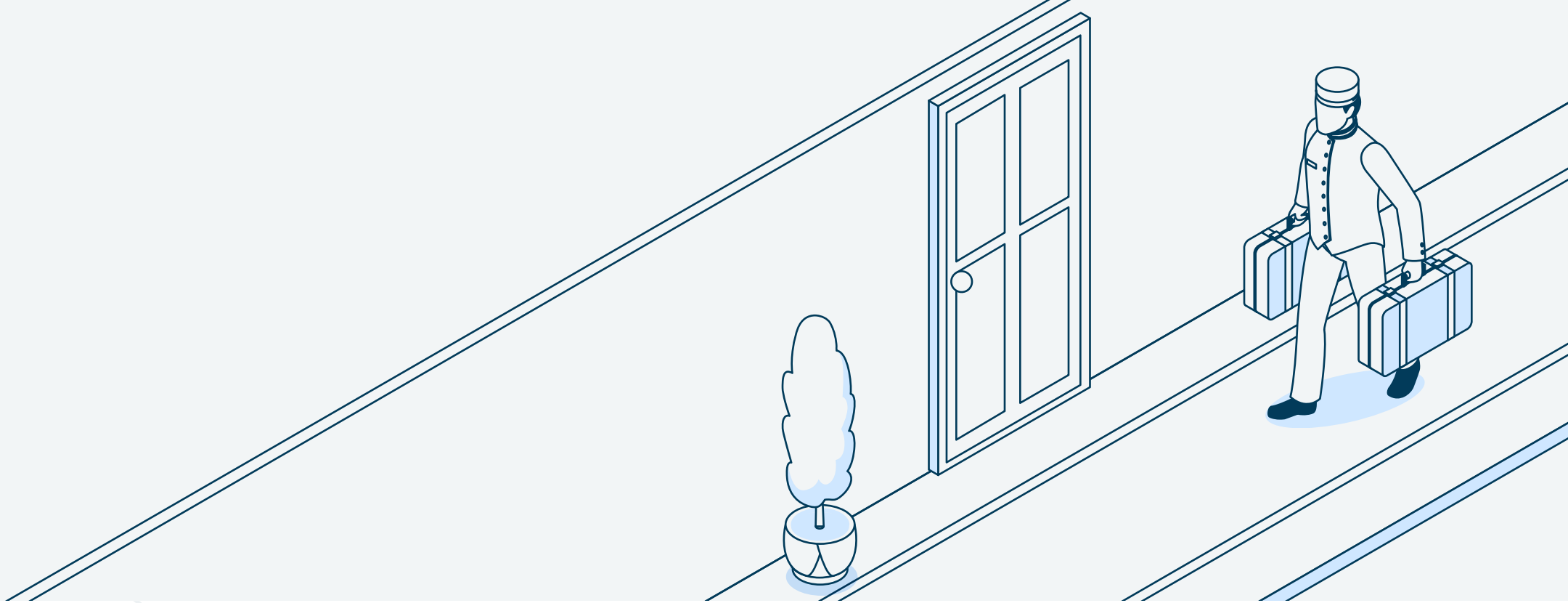

- Flexible Scheduling

- Backup Care

These two options pair well together because the flexible and/or predictive scheduling helps parents have more certainty over their shifts. Nevertheless, when childcare arrangements fall through, backup care ensures continuity of attendance and increases productivity of staff since working parents are not worrying about their temporary childcare solution.

- Flexible Scheduling

- Vouchers

Employers often couple flexible and/or predictive scheduling and vouchers to provide parents control at several levels. Vouchers help working parents use the childcare provider of their choice, while flexible scheduling enables them to have advanced notice of their schedule and arrange for childcare accordingly.

- Vouchers

- Subsidized Slots

To reduce challenges of access to care for their working parents, many employers will partner with a local or multi-state childcare provider to reserve slots specifically for their workforce. Then to reduce the barrier of affordability of care, employers partially offset the cost of care through vouchers to parents accessing the provider(s).

- Public Advocacy

- Flexible Scheduling

Many employers seek to implement flexibility in their scheduling for working parents, directly benefitting them, while also advocating for public investments in childcare to indirectly benefit their business and impact community supply of childcare.

FIND YOUR PARTNERS

Here are some other important resources to help you start your journey:

STATE LEAD AGENCIES

State Lead Agencies oversee regulations, financing and licensing.

- Can tell you about the supply and demand for childcare in your community/state.
- Can help you determine if your hourly-wage employees can benefit from existing state programs and subsidies—helping your organization understand how to design solutions to complement those existing benefits.

[Read More](#)

CHILDCARE RESOURCE AND REFERRAL AGENCIES (CCR&RS)

CCR&Rs work with families to locate available care and licensing support to local childcare providers.

- Can identify all the childcare providers in your geographic area of interest.
- Can assist working parents in navigating locally available options.

[Read More](#)

QUALITY AND ACCREDITATION RESOURCES

Resources to measure, track, and rate the quality of licensed childcare programs to incentivize quality options.

- Can help employers identify quality programs to partner with, locally, for their workforce.
- Help ensure that private investments from employers are effectively directed to improve quality standards locally in a community.

[Read More](#)

COMMUNITY DEVELOPMENT ORGANIZATIONS

Community development organizations lead and convene local stakeholders to improve childcare.

- Great place to start if your organization has no previous connections to childcare advocates or programs.
- May not always have early childhood-specific programming, but they often have strong partnerships within the community that can help employers navigate their options.

[Read More](#)

STATE AND LOCAL CHAMBERS OF COMMERCE

State and local business associations supporting the economic viability of a region.

- Can provide resources on the importance of early childhood education.
- Can connect you with like-minded employers, community stakeholders, and childcare advocates with whom you might partner.
- Can convene local stakeholders to collaboratively identify and advance childcare solutions.

[Read More](#)

Additional Resources

STATE OF CHILDCARE

[Child Care Market, Licensing & Quality by State](#)

[Policies, Funding and Demographics by State](#)

[Child Care Affordability](#)

[Employers & Returning to Work](#)

[Women in the Workplace 2020](#)

[The National Association for the Education of Young Children](#)

[Shared Services Alliance Resources](#)

ANALYSIS

[Sample Workforce Survey](#)

[Employer comparisons](#)

[Child Care cost calculator](#)

[Example of funding support](#)

LEARNING FROM OTHERS

[Case: Home Depot's Suite of Solutions](#)

[Case: Partnership and Public Advocacy](#)

[Case: Advocacy at local and state level](#)

[Case: Vermont business leaders](#)

[Case: Back-Up and Emergency Childcare](#)

[Case: Shared Services Alliance](#)

WHERE TO BEGIN

01

Understand the needs of your working parents

Your working parents will be your most valuable partners in your journey to find solutions that directly benefit them and your organization at the same time.

- Start with existing HR or dependent data that's available to you.
- Conduct surveys, host focus groups, or listen to EAPs/ERGs for the needs of your working parents.
- Open up lines of communication between frontline staff and line managers to senior leadership.
- Build parent feedback loops and tracking systems for ROI and continuous improvement.

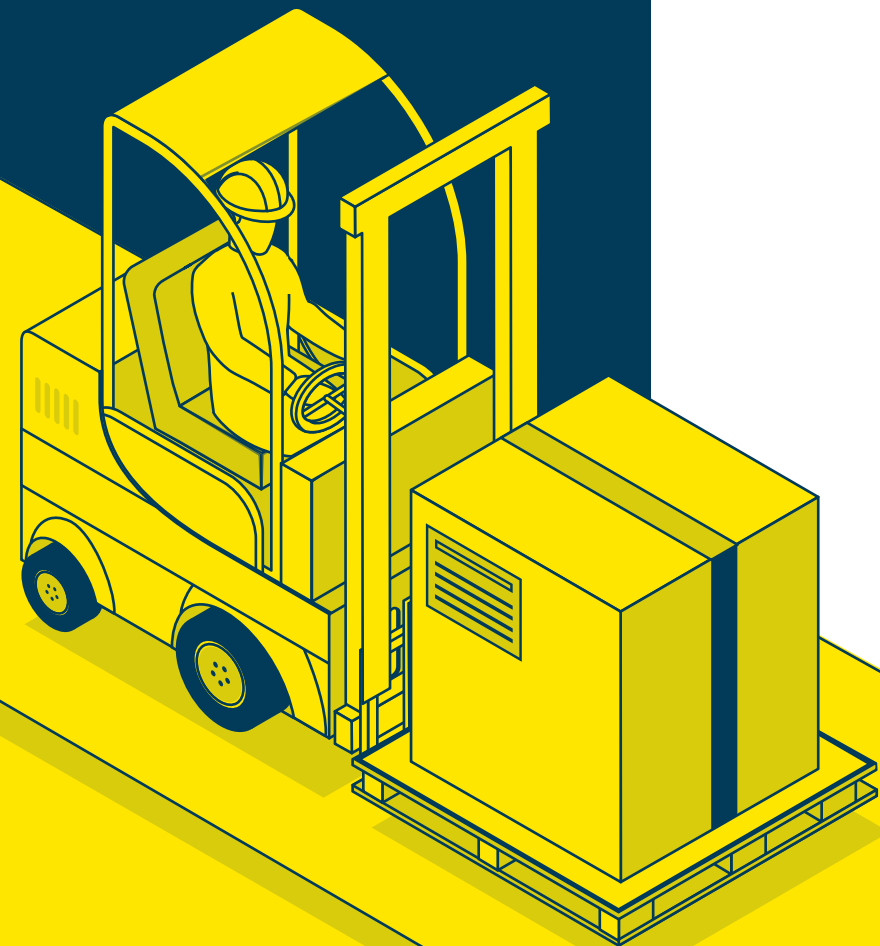

02

Find your partners and learn the landscape

You are not alone. Existing resources and community partners can provide expertise and information to guide you.

- Determine what you need to know about the availability of childcare in your community.
- Start Inside. How do employees feel about childcare arrangements? Are they satisfied and can their childcare providers recommend others? Do any members of your senior leadership team serve in leadership positions for any local childcare or advocacy organizations?
- Do your due diligence. Contact your state lead agency to learn more about the local childcare market. This agency likely sits within your state's Department of Education or Department of Health and Human Services.
- Learn about local coalitions of partner organizations, state and local chambers, CCR&RS, childcare providers, and advocates who are experts in your community and can be a resource for your journey.

03

Go for some quick wins and then build on them

Take small steps and get quick wins to generate momentum and enthusiasm for meeting this complex challenge.

- Establish flexibility where possible. Tap into EAPs/ERGs.
- Provide employees with a directory of all the local childcare programs in your community.
- Ask for feedback on these small changes—what is most helpful, what should be the next step?
- Build on these wins—what's next? plan for longer/larger changes.

THE BEST TIME TO START IS NOW.

Explore which childcare solutions will work for your business.

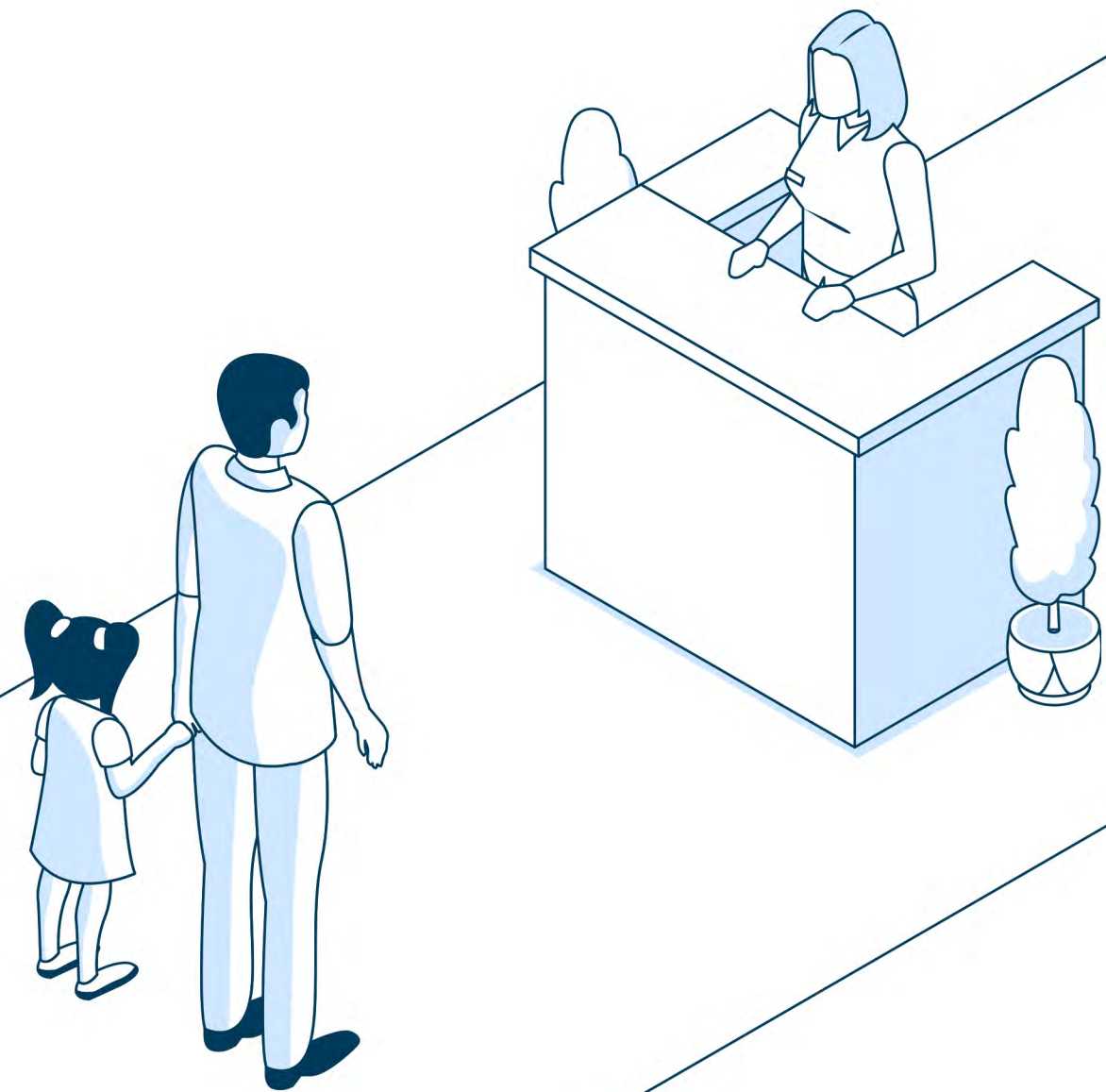

The U.S. Chamber of Commerce Foundation is dedicated to strengthening America's long-term competitiveness. We educate the public on the conditions necessary for business and communities to thrive, how business positively impacts communities, and emerging issues and creative solutions that will shape the future.

CONTACT US

education@uschamber.com

LEARN MORE

uschamberfoundation.org/earlyed